

# Jungle Babies

Designed by Casey York  
Featuring the Jungle collection by Jackie Shapiro for French Bull  
Size: 65" x 75"

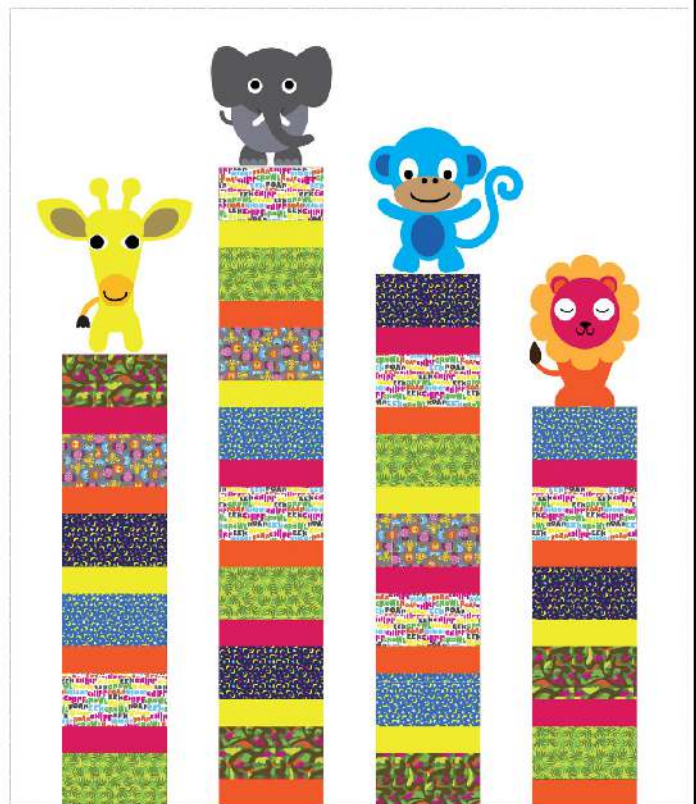

Check [www.windhamfabrics.com](http://www.windhamfabrics.com) Free Project section to see if there are any pattern updates before you start your quilt project



WINDHAM FABRICS

812 Jersey Ave ~ Jersey City, NJ 07310 ~ 201.659.0444 ~ FAX: 201.659.9719  
[www.windhamfabrics.com](http://www.windhamfabrics.com) email: [retail@windhamfabrics.com](mailto:retail@windhamfabrics.com)

# Jungle Babies

Page 2

## Jungle Collection

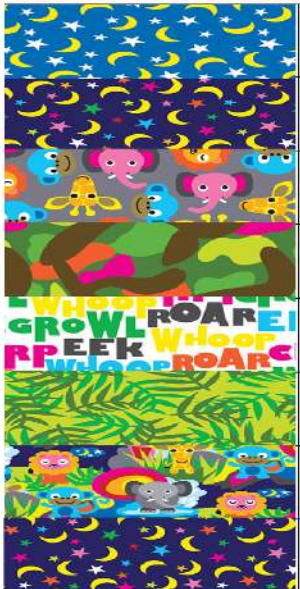
	40862-1	½ yd	Pieced Strips
	40862-2	½ yd	Pieced Strips
	40863-X Multi	½ yd	Pieced Strips
	40864-X Multi	½ yd	Pieced Strips
	40865-X Multi	½ yd	Pieced Strips
	40866-4	½ yd	Pieced Strips
	40861-X Multi	4 yds	Backing
	40862-2	1 yd	Bias Binding

## Palette Collection

	37098-10	1/8 yd	Giraffe & Lion Appliqués
	37098-48	1/8 yd	Giraffe & Monkey Appliqués
	37098-12	2 ½ yds	Background & Eye Appliqué
	37098-55	¼ yd	Elephant Appliqué
	37098-46	¼ yd	Giraffe & Lion Appliqués
	37098-17	½ yd	Giraffe & Lion Appliqués
	27098-54	½ yd	Lion Applique
	37098-29	½ yd	Monkey Appliqué
	37098-43	1/8 yd	Monkey Appliqué
	37098-02	1/8 yd	Elephant Appliqué

**Bating: 73" x 83" Paper-backed Light fusible web (15" wide): 1 ½ yards**

# Jungle Babies

Page 3

## Cutting instructions:

1. From each print fabric, cut (5)  $10\frac{1}{2}$ " X  $5\frac{1}{2}$ " rectangles (30 rectangles total; you will only use 26 of these).
2. From the pink, orange, and yellow solids, cut (8)  $10\frac{1}{2}$ " X 3" rectangles each (for a total of 24 rectangles). Set aside the rest of the solid fabrics for the appliqués.
3. From the natural solid, cut: (see Cutting Diagram below)
  - (1)  $10\frac{1}{2}$ " X 38" rectangle
  - (5)  $5\frac{1}{2}$ " X 75" strips
  - (1)  $10\frac{1}{2}$ " X  $15\frac{1}{2}$ " rectangle
  - (1)  $10\frac{1}{2}$ " X  $25\frac{1}{2}$ " rectangle
  - (1)  $10\frac{1}{2}$ " X 33" rectangleSet aside the rest of the natural solid for cutting the appliqués.

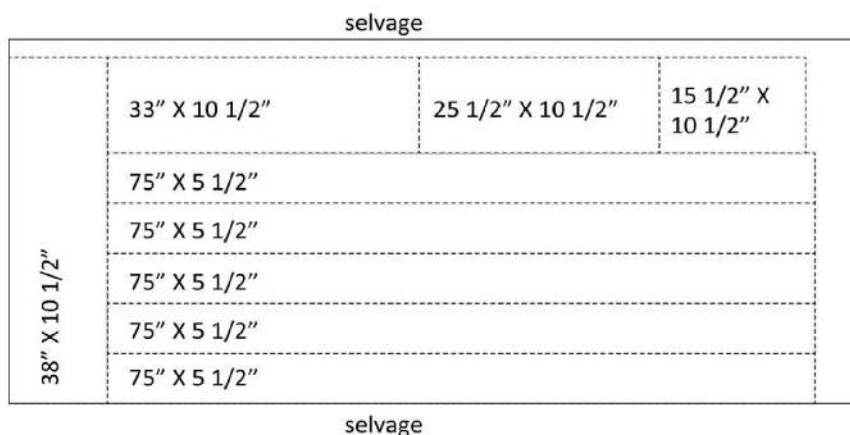

## Piece the background:

1. Piece the print and solid rectangles together along the  $10\frac{1}{2}$ " sides, alternating print and solid rectangles (see Assembly Diagram, below).
2. For Strip A, piece together (6) print rectangles and (5) solid rectangles; stitch the  $10\frac{1}{2}$ " X 33" neutral rectangle to the top of this strip along the  $10\frac{1}{2}$ " edge.
3. For Strip B, piece together (8) print rectangles and (8) solid rectangles; stitch the  $10\frac{1}{2}$ " X  $15\frac{1}{2}$ " neutral rectangle to the final print rectangle along the  $10\frac{1}{2}$ " edge.
4. For Strip C, piece together (7) print rectangles and (6) solid rectangles; stitch the  $10\frac{1}{2}$ " X  $25\frac{1}{2}$ " neutral rectangle to the top of this strip along the  $10\frac{1}{2}$ " edge.
5. For Strip D, piece together (5) print rectangles and (5) solid rectangles; stitch the  $10\frac{1}{2}$ " X 38" neutral rectangle to the final print rectangle along the  $10\frac{1}{2}$ " edge.



WINDHAM FABRICS

# Jungle Babies

Page 4

6. Stitch the 5 ½" X 75" neutral to the pieced strips along the 75" sides, alternating neutral and pieced strips as shown.

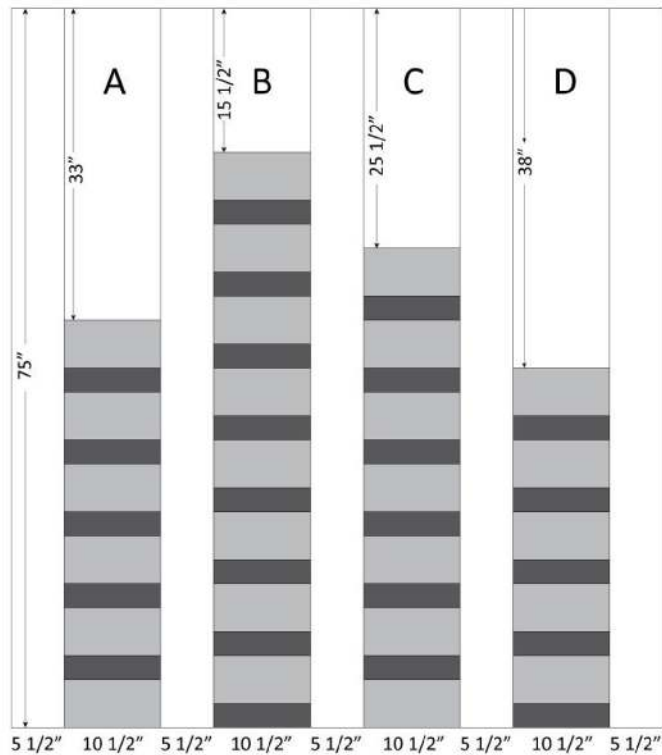

## Make and stitch the appliqués:

1. Print the templates for the Giraffe, Elephant, Monkey, and Lion; some templates will need to be taped together along the dotted lines (this is indicated on the templates). Templates have already been reversed for tracing onto fusible web.
2. Following the manufacturer's instructions, trace the templates onto the paper-backed fusible web. Copy the color recommendations onto each traced template.
3. Cut out the traced templates, leaving a 1/4" margin around the edges.
4. Following the manufacturer's instructions, fuse the traced templates to the **wrong** side of each appliqué fabric.
5. Using very sharp scissors to minimize fraying, cut out the fabric shapes along the traced lines.

# Jungle Babies

Page 5

6. Following the Placement Diagram, place the appliqués on the background. Be careful to position the appliqués at least 1 1/2" from the top edge of the background to allow room for squaring up and binding the quilt. Remove the paper backing from the fusible web and pin each appliqué in place as you go. Appliqué pieces will overlap one another.
7. For the elephant appliqué, cut slits in the head as indicated on the template. Tuck the mouth and tusk appliqués under these slits so that the trunk overlaps them.
8. For the monkey appliqué, tuck the lower edges of the white parts of the eyes beneath the snout.
9. When you are satisfied with your layout, use an iron to permanently fuse the fabric shapes to the background, again following the manufacturer's instructions (remember to remove pins before fusing!)
10. Stitch around each shape to secure to background. A zig-zag or machine blanket stitch can be used, using matching thread or invisible thread. A straight stitch can also be used, although this will result in more fraying of the appliqué fabrics along their edges.

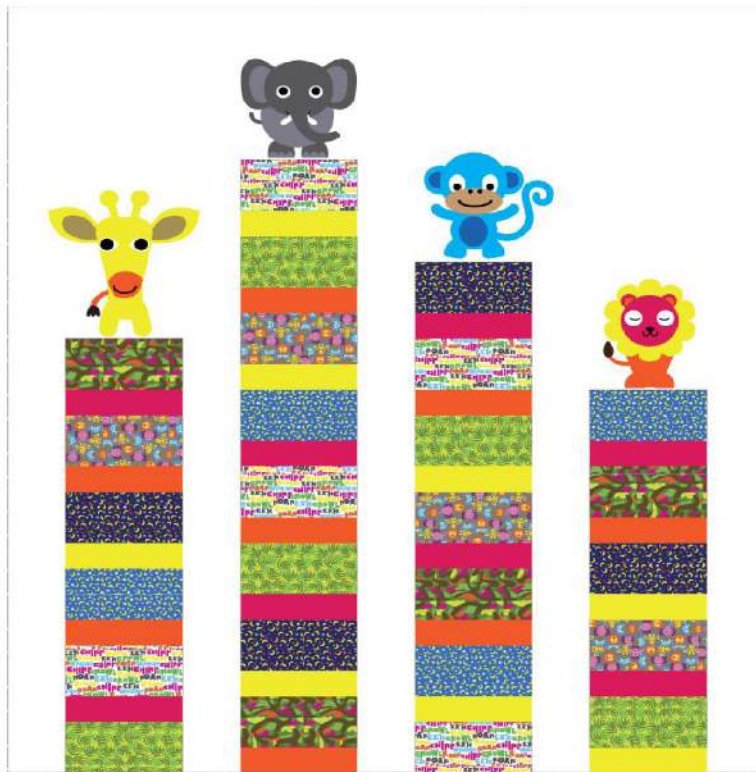

## Finish the quilt

1. Layer, baste, and quilt as desired. Bind using your favorite method.

Be sure to visit [www.windhamfabrics.com](http://www.windhamfabrics.com) to see the complete collection and to download this and other Free Projects

## Template Printing Instructions

- Print using the latest version of Adobe Reader (available for free at [www.adobe.com/products/reader.html](http://www.adobe.com/products/reader.html)). *Do Not* print from your browser, as this will not give you the full range of scaling options.
- Print full size: in print dialog box, set printer options to ***“Do not scale”*** or ***“Actual Size.”***
- Refer to the grey one inch box to ensure printing at correct size
- Some templates will need to be taped together; use the dashed lines to align the halves of each template
- Templates do not include seam allowance

1" X 1"

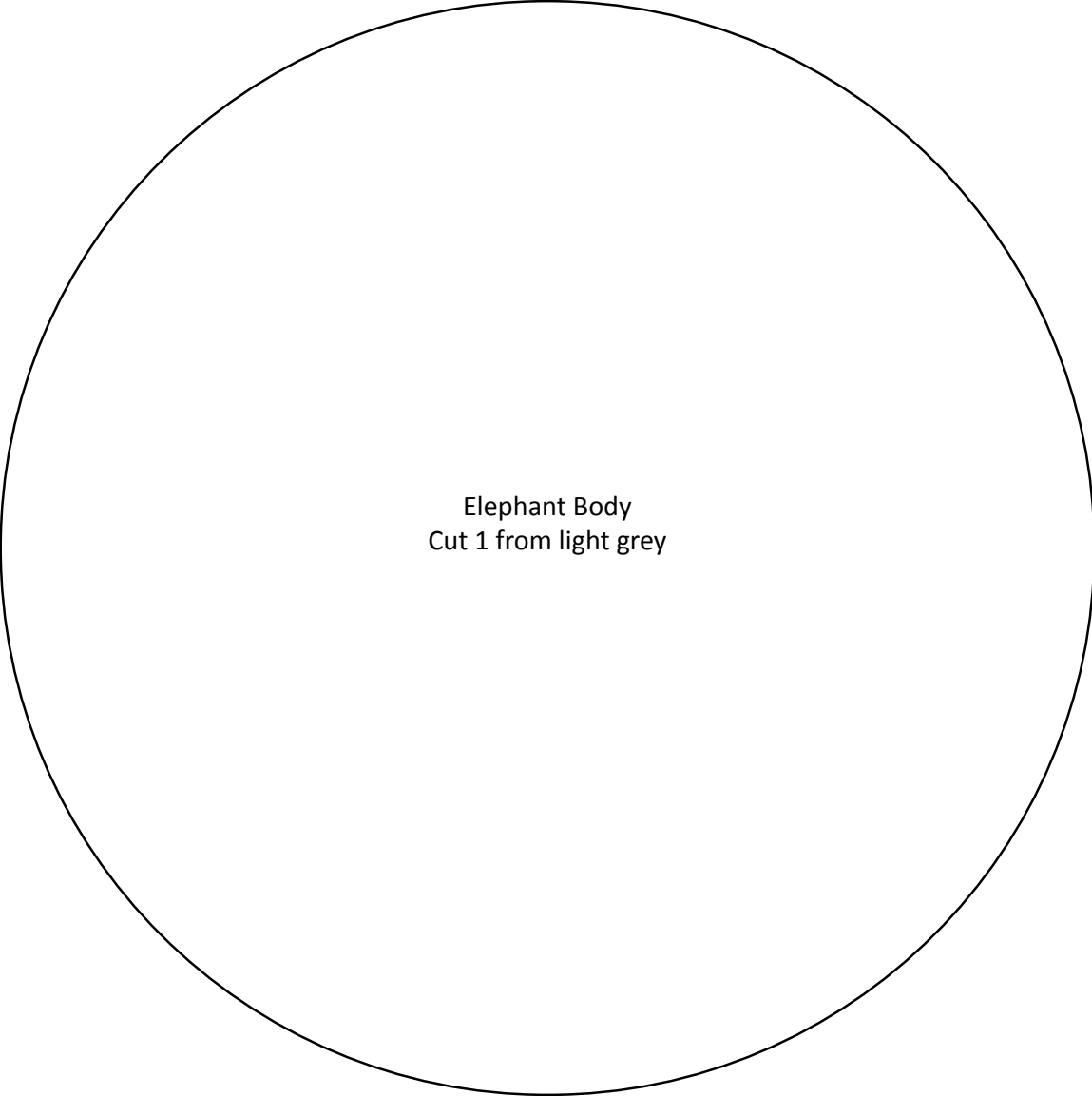

Elephant Body  
Cut 1 from light grey

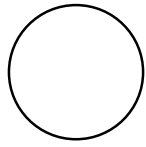

Pupil  
Cut 2 from black



Smile  
Cut 1 from black

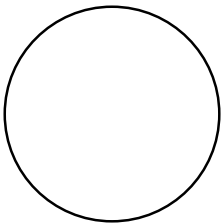

Eye  
Cut 2 from white

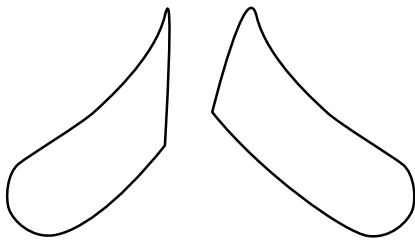

Tusks  
Cut 1 each from chalk

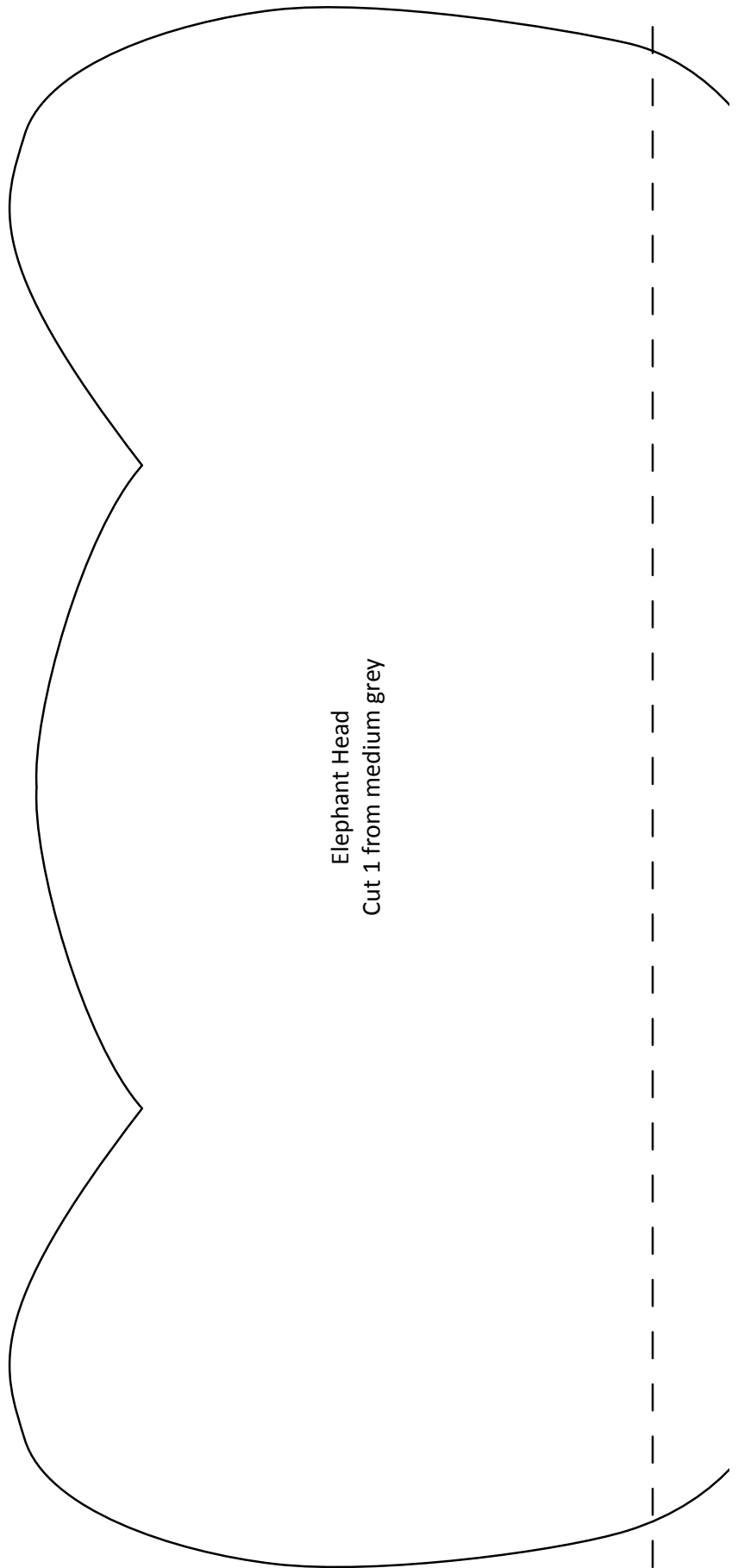

Elephant Head  
Cut 1 from medium grey

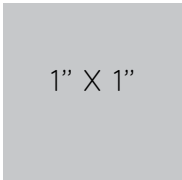

1" X 1"

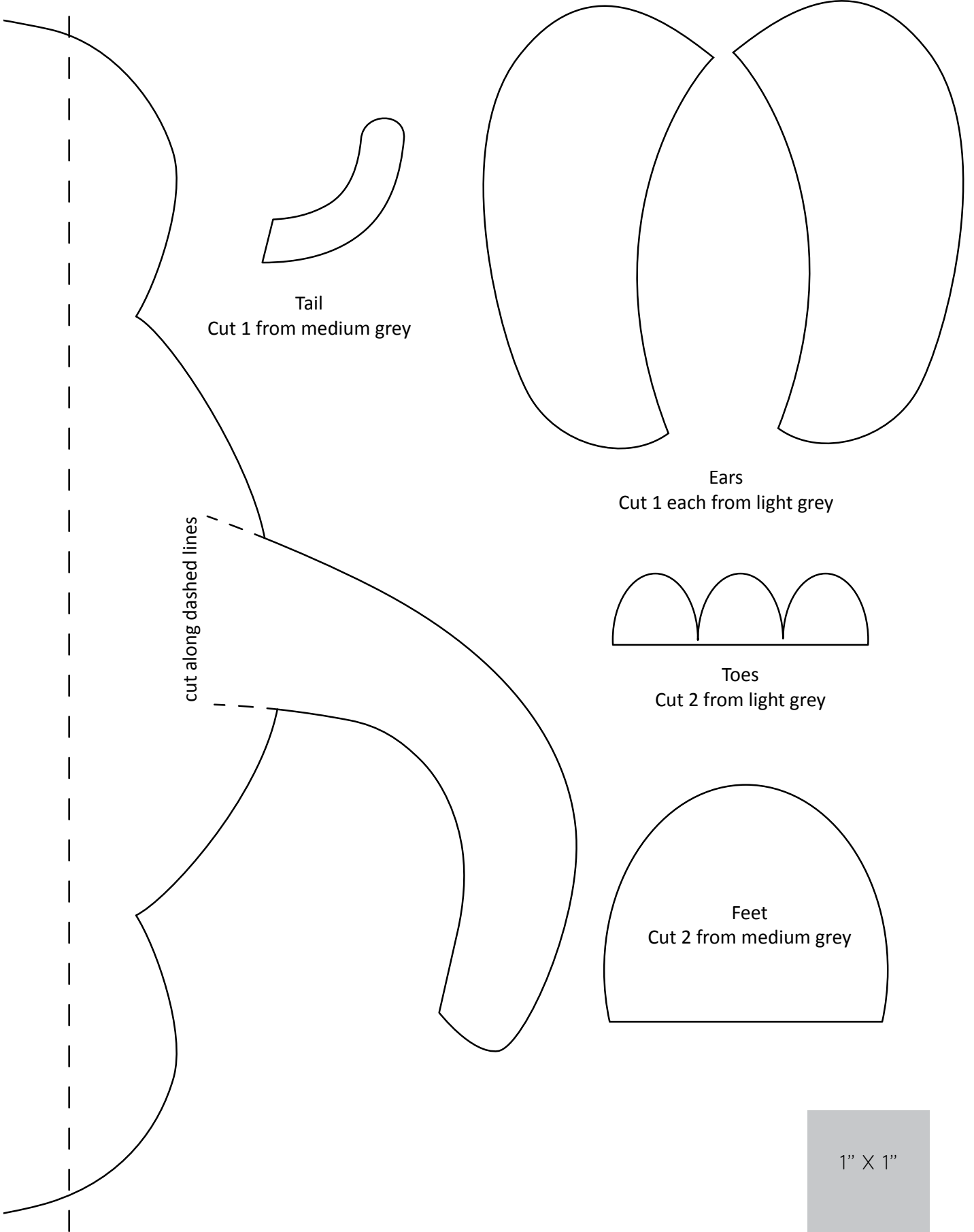

Tail  
Cut 1 from medium grey

Ears  
Cut 1 each from light grey

Toes  
Cut 2 from light grey

Feet  
Cut 2 from medium grey

cut along dashed lines



1" X 1"



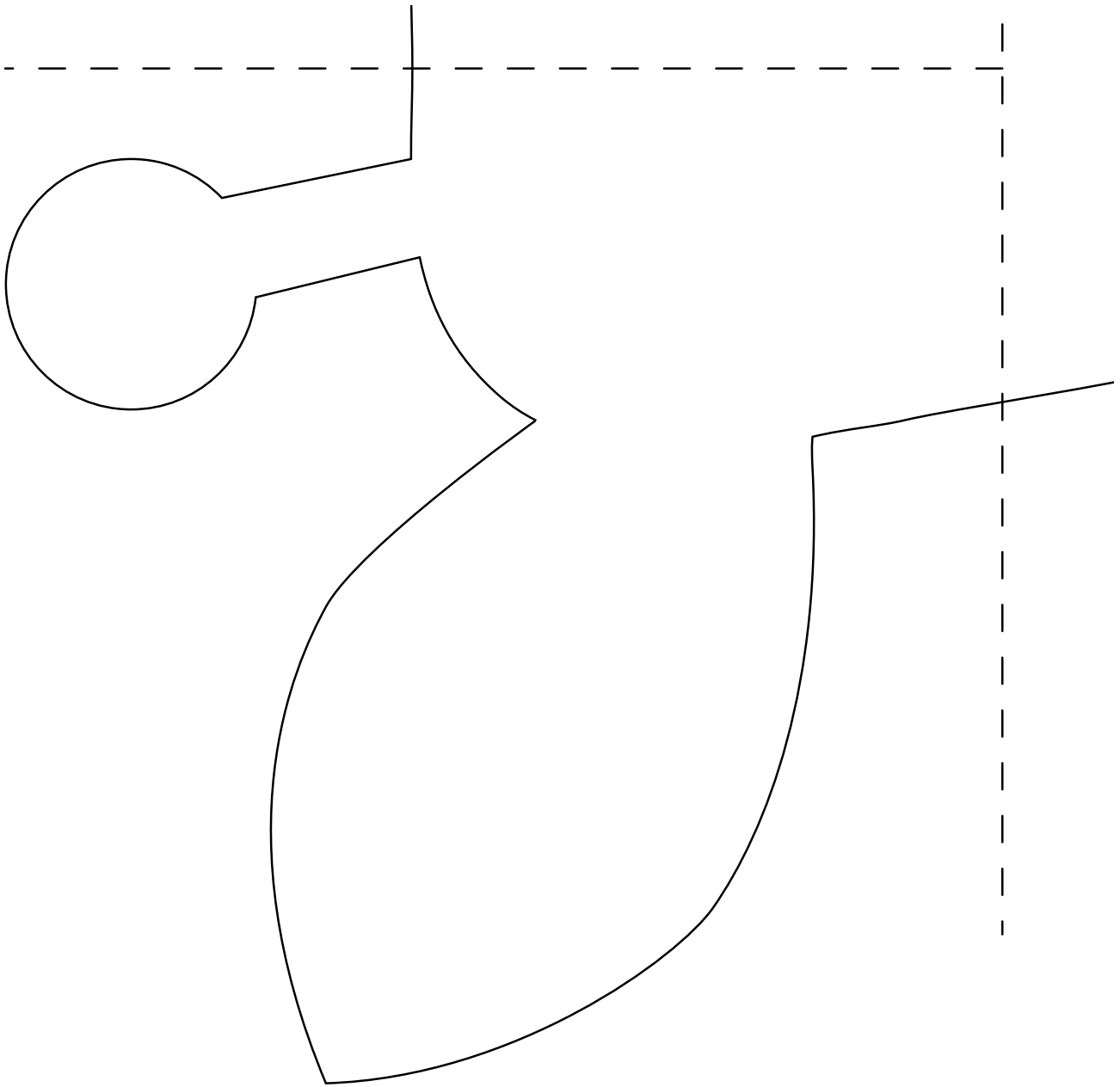

1" X 1"

1" X 1"

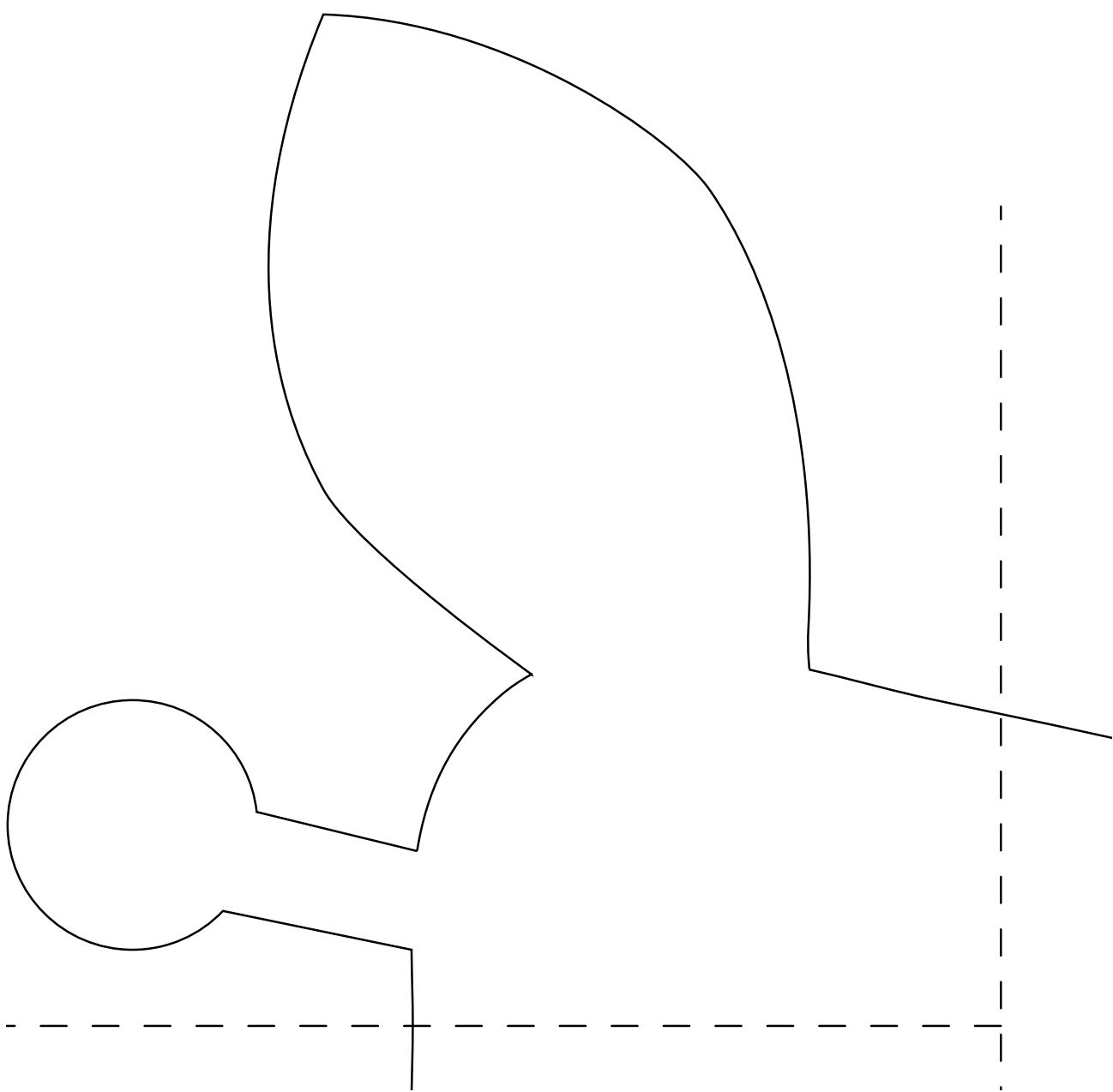

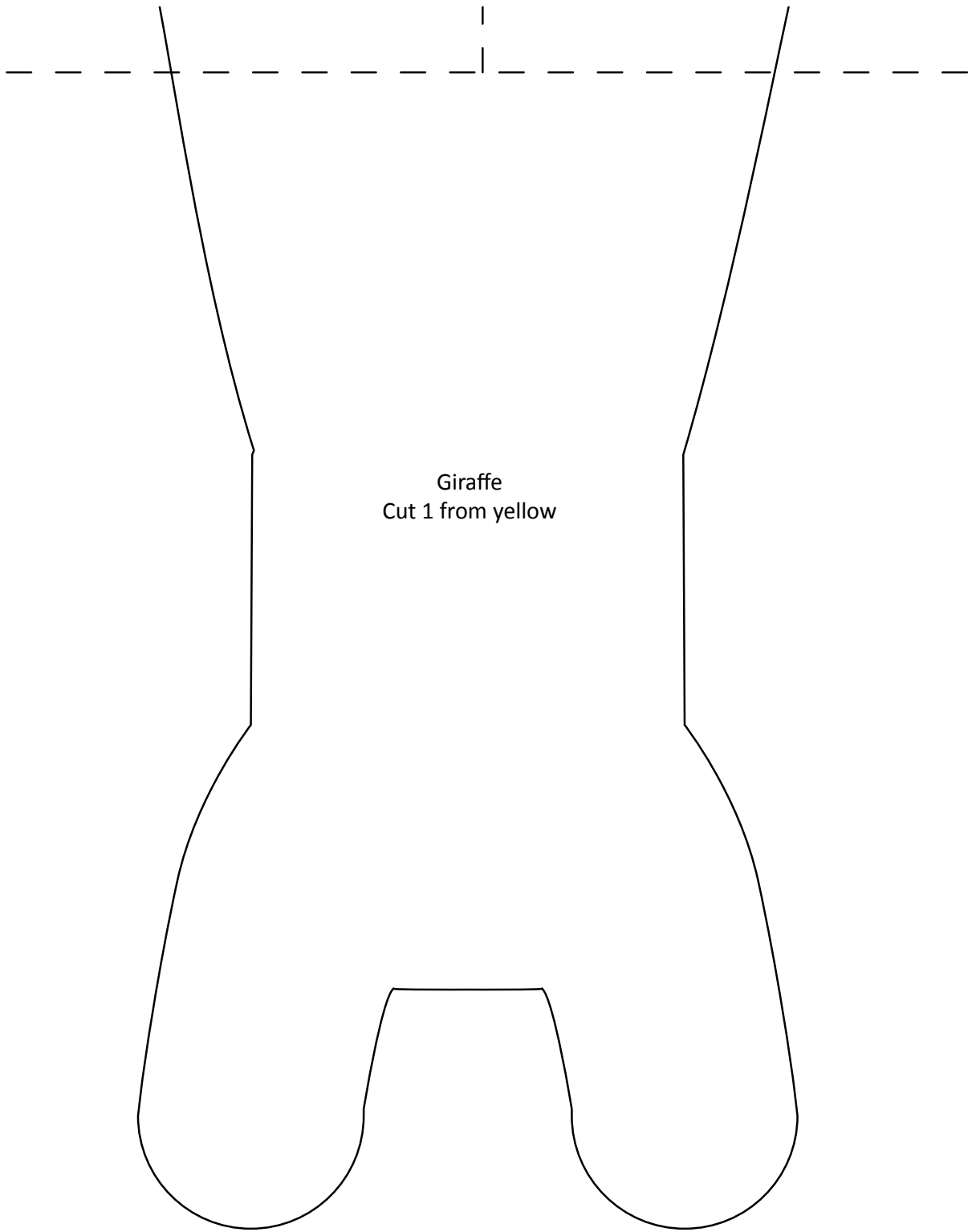

Giraffe  
Cut 1 from yellow

1" X 1"

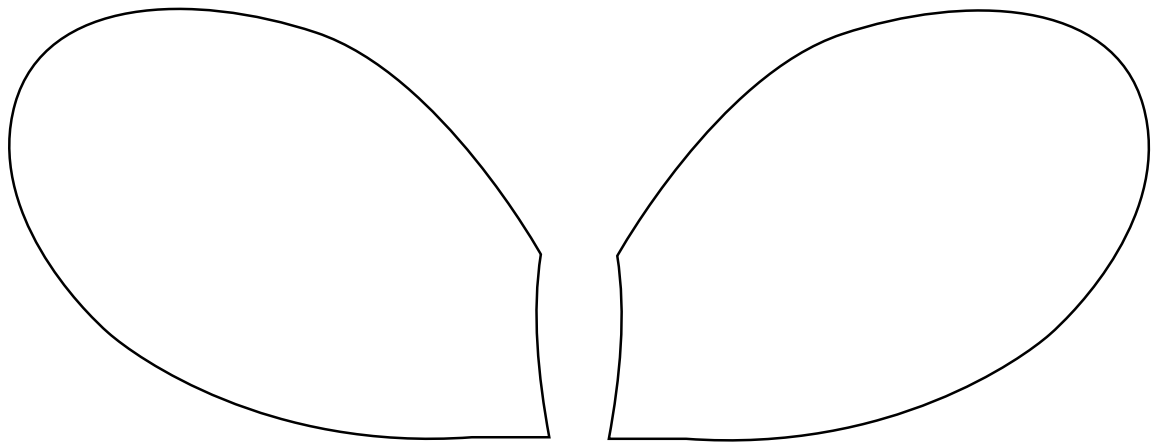

Ears  
Cut 1 each from tan

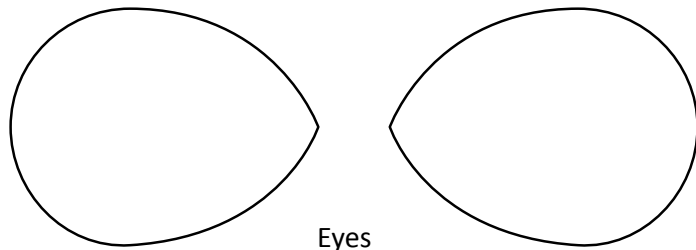

Eyes  
Cut 1 each from white

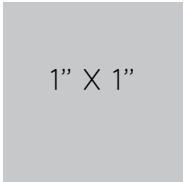

1" X 1"

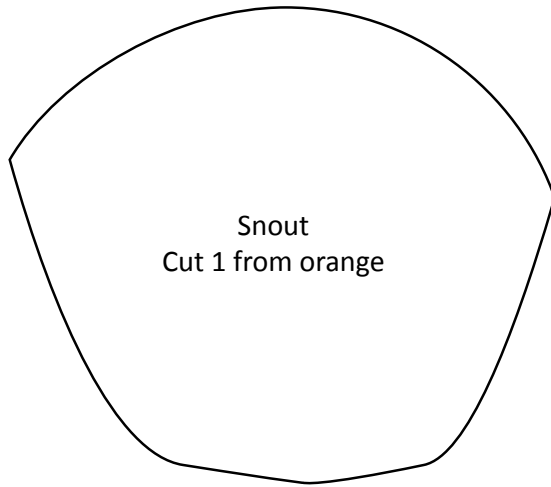

Snout  
Cut 1 from orange

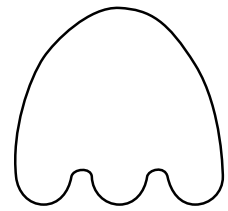

Tail  
Cut 1 from brown

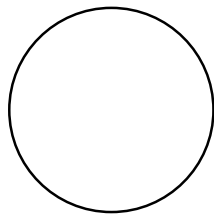

Pupil  
Cut 2 from black



Smile  
Cut 1 from black

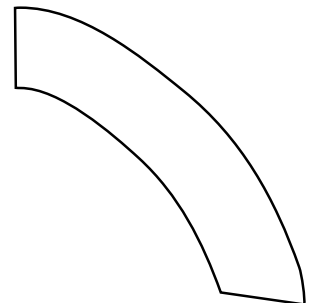

Tail  
Cut 1 from orange

1" X 1"

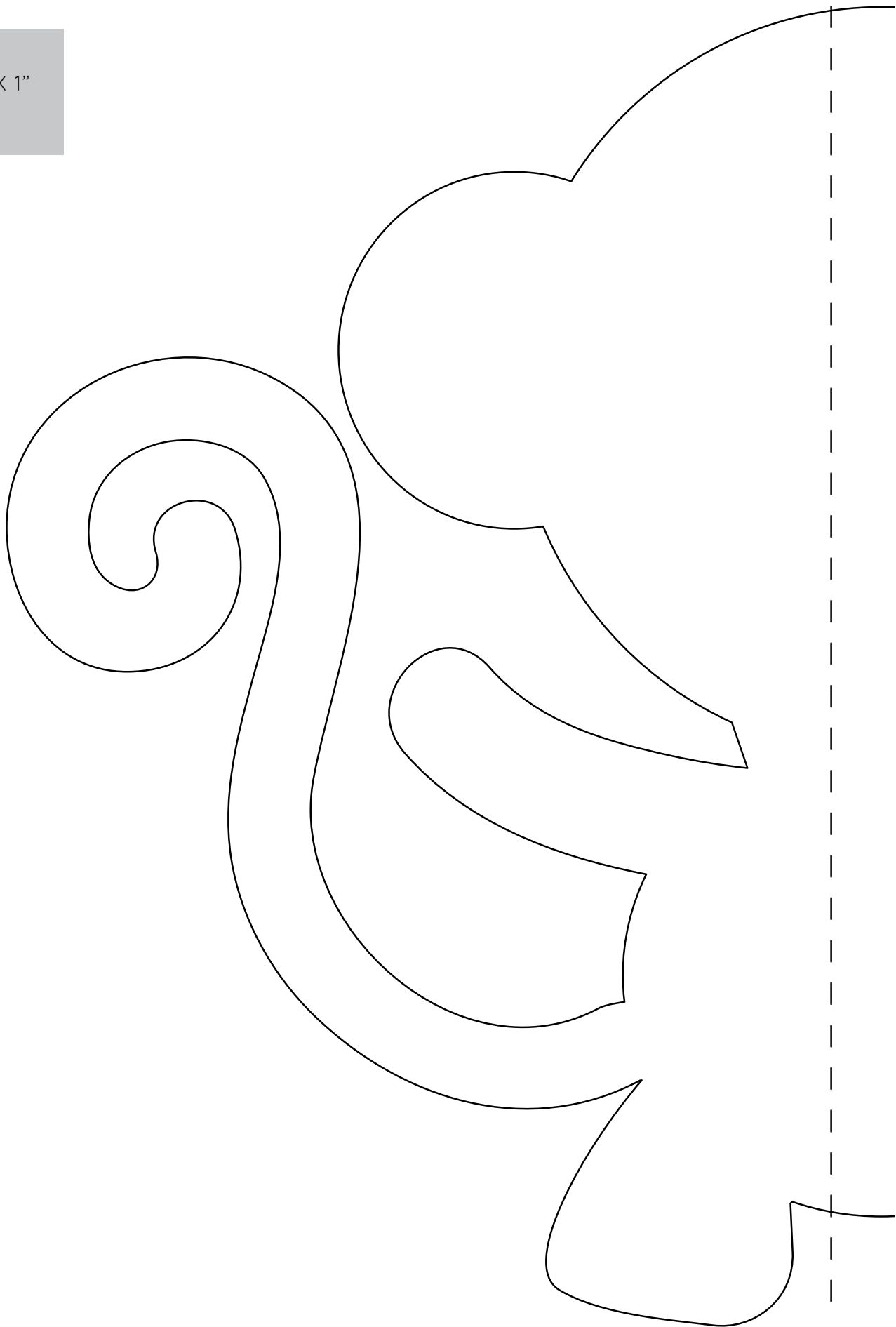



1" X 1"

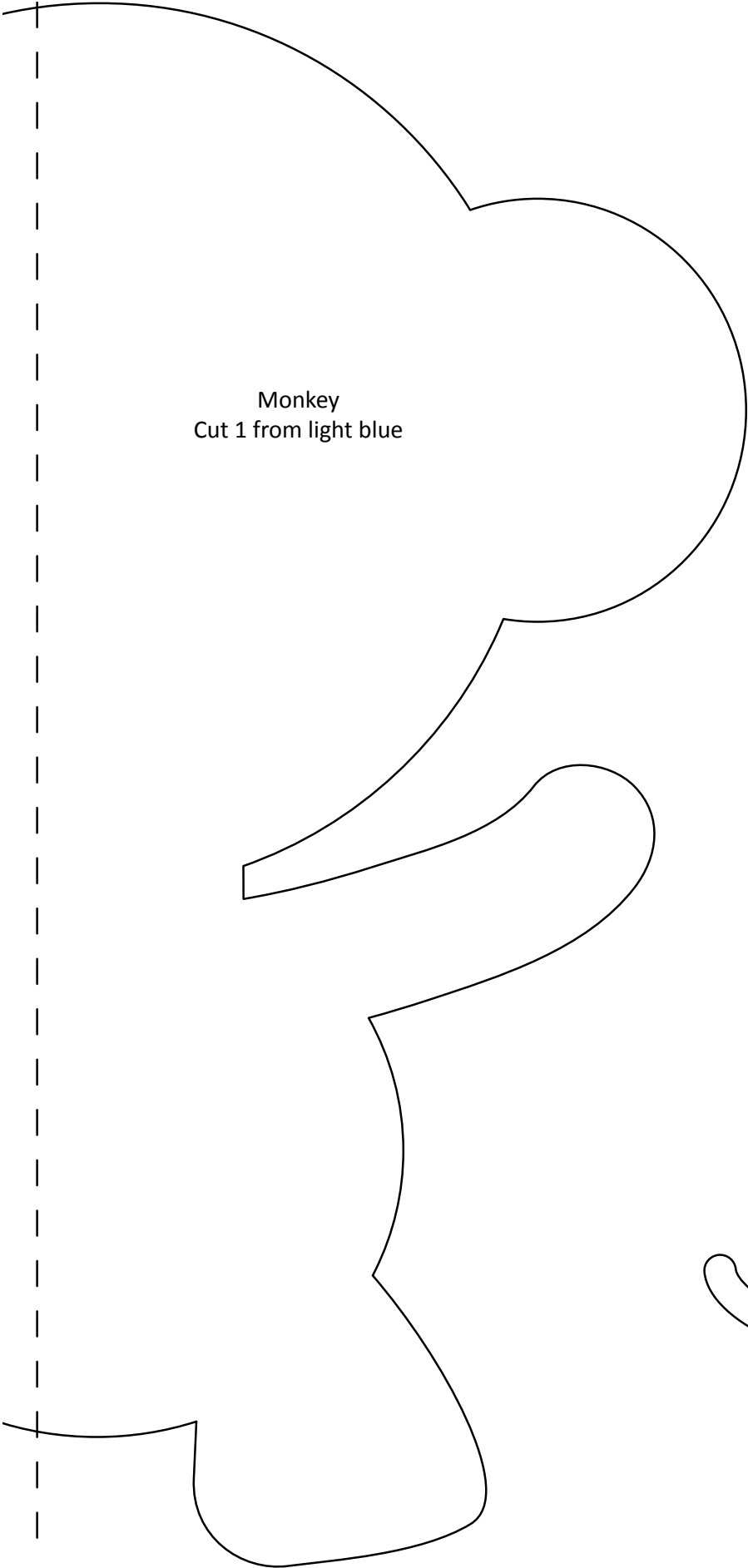

Monkey  
Cut 1 from light blue

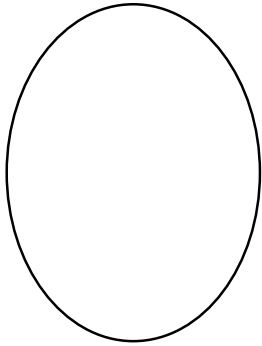

Eye  
Cut 2 from white



Nostril  
Cut 2 from black

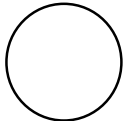

Pupil  
Cut 2 from black



Smile  
Cut 1 from black

1" X 1"

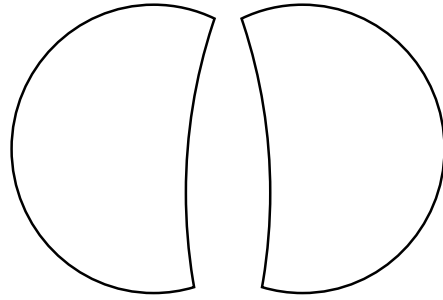

Ears

Cut 1 each from medium blue

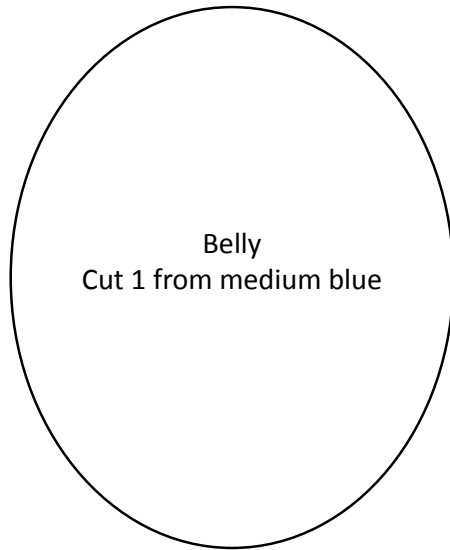

Belly

Cut 1 from medium blue

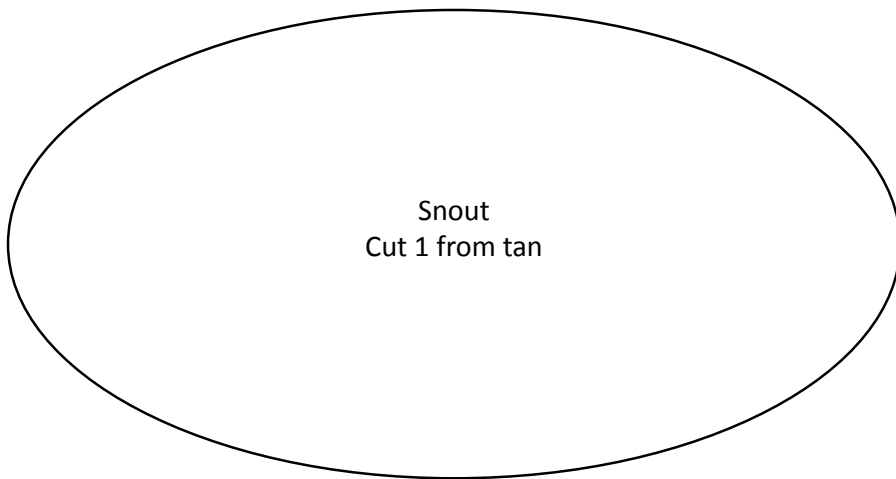

Snout

Cut 1 from tan

1" X 1"

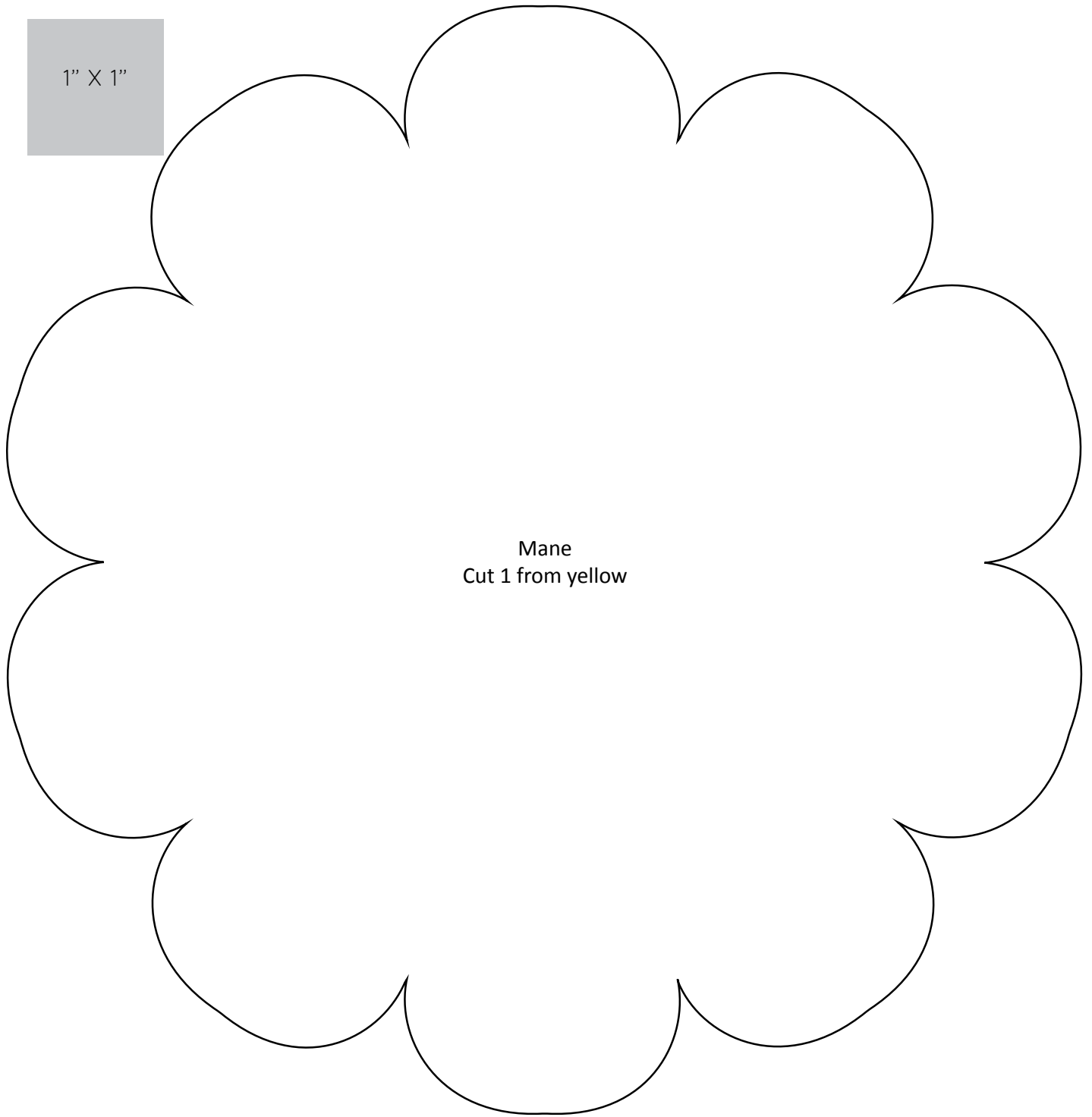

Mane  
Cut 1 from yellow

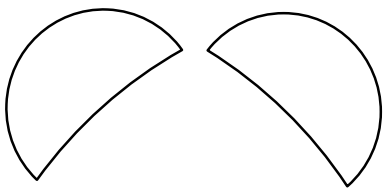

Ears  
Cut 1 each from orange

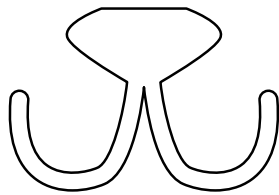

Mouth  
Cut 1 from black



Eyelid  
Cut 2 from black

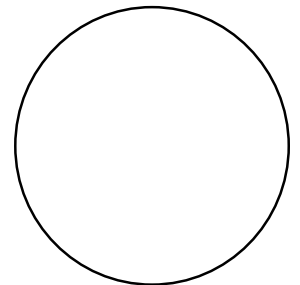

Eye  
Cut 2 from white



1" X 1"

